

HEATSTRIP® 

Outdoor Heating



HEATSTRIP® Elegance

With superior technology & style, world-leading design and unique "off-white" colour, the new HEATSTRIP Elegance will blend in with the white ceiling in your alfresco area.

FEATURES

- Electric radiant outdoor heater
- Slimline design and "off-white" colour
- New more compact and higher output design
- Corrosion-resistant for most environments
- Ideal for your protected outdoor alfresco area or indoor area
- 2 year residential warranty and 1 year commercial

TABLE LAYOUT



Materials of Construction

High temperature off-white ceramic coated extruded alloy. IP55 Rated.

MODEL	RUNNING COSTS	POWER (watts)	CURRENT (amps)	DIMENSIONS (LxWxD)mm	WEIGHT (kgs)	LEAD LENGTH (mm)	PLUG	HEATING AREA (m ²)
THE1800	45c/hr	1800	7.5	974x170x48.5	4	1000	Yes	3-4
THE2400	60c/hr	2400	10	1204x170x48.5	7	1000	Yes	4-5
THE3600	90c/hr	3600	15	1804x170x48.5	9	1000	No	5-6

*Running costs based on \$0.25/kWh. Heating area is for a protected outdoor site.



Not actual size.

HEATSTRIP® Classic

Premium quality, stylish & slimline electric radiant heaters perfect for protected outdoor and indoor applications.

FEATURES

- Electric radiant heater ideal for your protected alfresco area, pergola, verandah, cafe or difficult to heat indoor area
- Stylish, sleek, unobtrusive design with black front profile
- Corrosion protected for even the toughest environment
- Easy DIY installation for 2 models and multiple mounting options
- 2 year residential warranty and 1 year commercial warranty
- Australian designed and engineered

TABLE LAYOUT

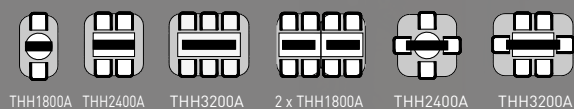

Materials of Construction

High temperature ceramic coated extruded alloy. IP55 Rated.

MODEL	RUNNING COSTS	POWER (watts)	CURRENT (amps)	DIMENSIONS (LxWxD)mm	WEIGHT (kgs)	LEAD LENGTH (mm)	PLUG	HEATING AREA (m ²)
THH1800A	45c/hr	1800	7.5	1104x165x48	6	1000	Yes	3-4
THH2400A	60c/hr	2400	10	1364x165x48	7	1000	Yes	4-5
THH3200A	80c/hr	3200	13.3	1774x165x48	9	1000	No	5-6

*Running costs based on \$0.25/kWh. Heating area is for a protected outdoor site.



Not actual size.

HEATSTRIP® Intense

The new HEATSTRIP Intense Wall/Ceiling mounted electric infra-red heaters are a modern and attractive outdoor heating solution. The high temperature output of the HEATSTRIP Intense is perfect for outdoor sites, high ceilings and hard to heat indoor applications. These heaters can be a feature to any outdoor area.

FEATURES

- Ideal for undercover protected and semi-exposed outdoor locations
- Easy DIY installation for 2200W unit, 3200W heater must be installed by a licensed electrician
- High quality construction with a new hexagonal grille
- Carbon filament infra-red heating element provides high performance instant heat
- 2 year residential and 1 year commercial warranty.

Materials of Construction

High temperature black ceramic coated extruded alloy. IP55 Rated.

MODEL	RUNNING COSTS	POWER (watts)	CURRENT (amps)	DIMENSIONS (LxWxD)mm	WEIGHT (kgs)	LEAD LENGTH (mm)	PLUG	HEATING AREA (m ²)
THY2200	55c/hr	2200	9.2	1068x120x90	6	1000	Yes	5-9
THY3200	80c/hr	3200	13	1270x120x90	7	1000	No	8-13

*Running costs based on \$0.25/kWh. Heating area is for a semi exposed/protected outdoor site.

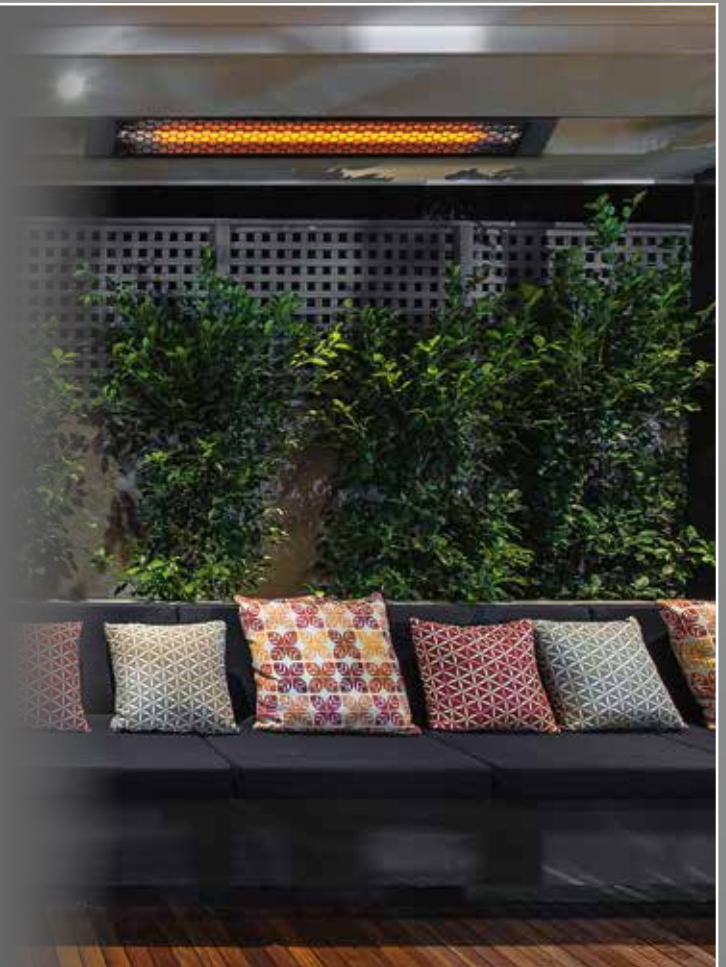

HEATSTRIP® Max

HEATSTRIP Max is an Australian designed and engineered range of high intensity electric infra-red radiant heaters ideal for tough outdoor and indoor heating applications. The Max heater is a high temperature radiant heater with a unique low-glow, shatter proof heating element, perfect for outdoor alfresco areas, balconies, pergolas, verandah, courtyards, ware-houses etc.

FEATURES

- High temperature electric radiant heater ideal for higher ceilings or more exposed locations
- Unique "low glow" Incoloy element – no more blinding light
- Commercial grade quality and construction
- Corrosion resistance provided by the anodized alloy casing
- Easy DIY installation for the THX2400 unit, THX3600 must be installed by a licensed electrician
- 2 year warranty
- Australian designed and engineered

Materials of Construction

Anodised alloy casing and end caps, chromed grille. IPX5 Rated.

MODEL	RUNNING COSTS	POWER (watts)	CURRENT (amps)	DIMENSIONS (LxWxD)mm	WEIGHT (kgs)	HEATING* AREA (m ²)
THX2400	60c/hr	2400	10	854x170x80	6	10 Supplied with lead & plug DIY
THX3600	90c/hr	3600	15	1184x170x80	8	15 Must be hard wired

*Running costs based on \$0.25/kWh. Heating area for an enclosed outdoor area.



Not actual size.

	<p>Ceiling Mounts</p> <p>Wall Mount</p> <p>Chain/Wire Suspension*</p> <p>Flush Mount Enclosure</p> <p>Extension Mount Bracket</p>
	<p>Standard Bracket *(Chain not included)</p> <p>Flush Mount Enclosure Opt. Accessories</p> <p>Extension Mount Bracket Opt. Accessories</p>
ELEGANCE	<p>ZBRAK-113W (Included with heater)</p> <p>THEAC-040 (For THE1800) THEAC-041 (For THE2400) THEAC-042 (For THE3600)</p> <p>THEAC-043(300mm) THEAC-045 (900mm) THEAC-044(600mm) THEAC-046 (1200mm)</p>
CLASSIC	<p>ZBRAK-113S (Included with heater)</p> <p>THHAC-010 (for THH1800A) THHAC-011(For THH2400A) THHAC-012 (for THH3200A)</p> <p>THHAC-005(300mm) THHAC-007 (900mm) THHAC-006 (600mm) THHAC-008(1200mm)</p>
MAX	<p>ZBRAK-132S (Included with heater)</p> <p>THXAC-030 (for THX2400) THXAC-031(for THX3600)</p> <p>THHAC-005(300mm) THHAC-007 (900mm) THHAC-006 (600mm) THHAC-008(1200mm)</p>
INTENSE BLACK	<p>ZBRAK-132B (Included with heater)</p> <p>THYAC-051(for THY2200) THYAC-052 (for THY3200)</p> <p>THYAC-047 (300mm) THYAC-049 (900mm) THYAC-048 (600mm) THYAC-050(1200mm)</p>

Which product do I need?

APPLICATION	ELEGANCE (THE)	CLASSIC (THH-A)	MAX/INTENSE (THX/THY)
Outdoor Heating – undercover, well protected area with ceiling height less than 2.7m (alfresco, verandah, café)	✓	✓	✓
Outdoor Heating – undercover, well protected area with ceiling height from 2.7m to 3.0m (alfresco, verandah, café)			✓
Outdoor Heating – exposed area (alfresco, café, verandah, balcony)			✓
Indoor Insulated areas – commercial (classrooms, offices, nursing homes, hospitals) residential (shed, garage etc)	✓	✓	
Indoor Open Insulated areas requiring spot heating - factory, halls, warehouse, workshop, shed, garage, sports facility	✓	✓	✓

Mounting Heights

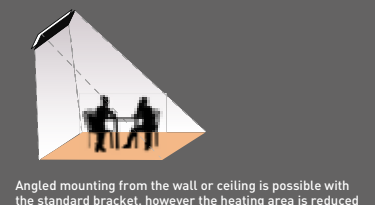
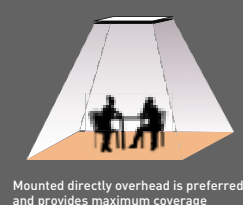
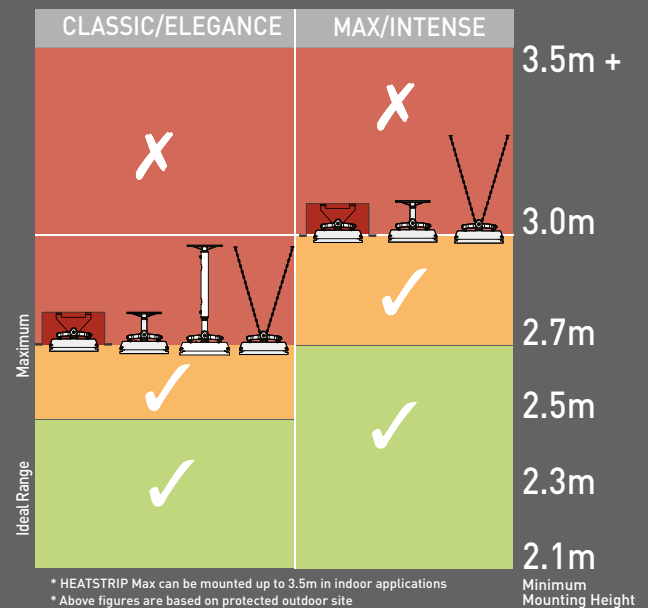

DIY (TT-MTR-PLUG)

TT-MTR-PLUG timer switch provides an easy DIY installation and remote control of plug-in heaters.

- Plug-in DIY timer switch
- On/Off function with LED indicators
- Automatic timer – 1 / 2 / 4 hour options
- Remote control included
- Max. 10 amps, can be used with all heaters 2400W or less



HARDWIRED (TT-MTM)

TT-MTM wall mounted controller and remote control provides ON/OFF control, 3 heat options and timer settings.

- On/Off function with LED indicators
- Suitable for operation of single or multiple heaters
- 3 Heat settings - High / Medium / Low
- Automatic timer control - 1/2/4 hour options
- Must be hard-wired. Maximum 16 amps direct wired capacity (for additional heaters, use a relay/contactors)
- Remote control included
- Suitable to be used with Classic, Elegance and Max ranges



Intense Portable Electric Heater (THY2200P)

HEATSTRIP® Intense Portable

The HEATSTRIP Intense electric heater is the classy and redefined solution for when a portable, easy DIY electric heating is required. Incorporating a sleek and robust stand with a 2200W HEATSTRIP Intense heater, it is ideal for spot heating of tables, lounges, entertaining areas and workstations, suitable for both indoor and outdoor applications.

FEATURES

- Ideal for indoor and outdoor use. In-built wheels for easy portability and storage.
- Heater includes a high performance carbon filament electric infra-red element, providing instant heat.
- Components are sub-assembled for easy final DIY installation, with a fully concealed power cable
- High quality, robust, all black construction, with new hexagonal heater grille
- 2 year residential and 1 year commercial warranty

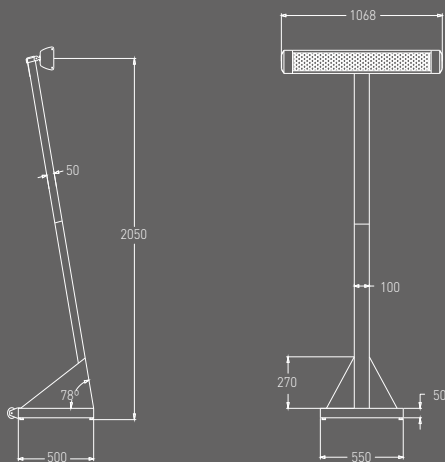

Note: Connection to power source is at bottom of stand, not shown in image. Measurements are in mm

Materials of Construction

Heater: Black anodized alloy casing & endcaps, powder coated grille
Stand: Powder coated mild steel IPX5 Rated

MODEL	RUNNING COSTS	POWER (watts)	CURRENT (amps)	DIMENSIONS (WxDxH)mm	WEIGHT (kgs)	HEATING AREA (m²)	LEAD LENGTH (mm)
THY2200P	55c/hr	2200	9.2	1068x2050x500	20	5-9	3000

*Running costs based on \$0.25/kWh. Heating area for a semi-protected enclosed outdoor area.



Not actual size.



**UPGRADED
FEATURES**

NEW FEATURE



**Electronic finger pull
on/off ignition**



**Optional heater cover
available (TGHCOVER)**

The new HEATSTRIP portable LPG heater incorporates world leading design, quality, heat performance and efficiency to provide a stylish, robust and elegant solution for your outdoor area, alfresco, balcony, patio etc.

FEATURES

- 34 MJ, 4 tile commercial quality ceramic burner to be used with a 9kg LPG bottle (not included)
- NEW Electronic finger pull ignition (battery operated), with tilt safety switch and flame failure device. Fully concealed gas pipes and bottle
- Heater head components made from high quality Stainless Steel with high temperature paint coating
- World class wind protection rating at 16 kilometres an hour
- Protective grille and reflector included as standard, to guarantee safe operation. Reflector design ensures that only a minimum of 500mm overhead clearance is required.
- Components are sub-assembled for easy DIY Installation
- Suitable for residential and commercial applications

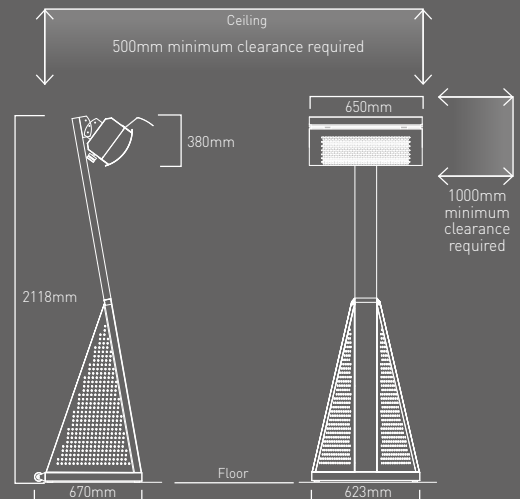

Note: Suitable for outdoor use only.

Materials of Construction

Head: Stainless steel (430SS) with high temperature paint coating.
Stand: E-coated mild steel with powder coated finish

MODEL	TILES	MJ	IGNITION	DIMENSIONS (WxDxH)mm	RUNNING COST*	WEIGHT (kg)	HEATING AREA (sqm ²)
TGH34PL-2	4	34	Electronic finger pull	650x670x2118	\$2.00/Hr	31.5	16

*Based on \$25 per gas bottle refill and run time of 12.5 hrs

**UPGRADED
FEATURES**

FEATURES



Electronic finger pull on/off ignition



Wall mounting bracket



4 tile commercial ceramic burner

OPTIONAL ACCESSORIES



Heat shield (TGHAC-003)



Extension pole (TGHAC-004)

The new and upgraded HEATSTRIP Wall mounted Natural Gas (NG) heater is a stylish addition to any outdoor area, where mains Natural Gas is preferred. World class design aesthetics, heat output and performance, for both residential and commercial applications.

FEATURES

- 34 MJ, 4 tile commercial quality ceramic burner, for connection to mains Natural Gas (NG)
- NEW Electronic finger pull ignition and flame failure device
- World class wind protection rating of 16 kilometres an hour
- Constructed from Stainless Steel with high temperature paint coating
- Protective grille and reflector included as standard, to guarantee safe operation. Reflector design ensures that only a minimum of 500mm overhead clearance is required. Optional accessories for low clearance or ceiling mounting are available
- Wall mounting bracket allows for multiple mounting angles, and is extremely robust to provide strength and support. Gas regulator included
- Available in LPG version (TGH34WLPG)
- 2 year residential and 1 year commercial warranty

Materials of Construction

Head: Stainless steel (430SS) with high temperature paint coating.

MODEL	TILES	MJ	IGNITION	DIMENSIONS (WxDxH)mm	RUNNING COST*	WEIGHT (kg)	HEATING AREA (sqm ²)
TGH34WN-2	4	34	Electronic finger pull	650x190x380	68c/Hr	11.5	16

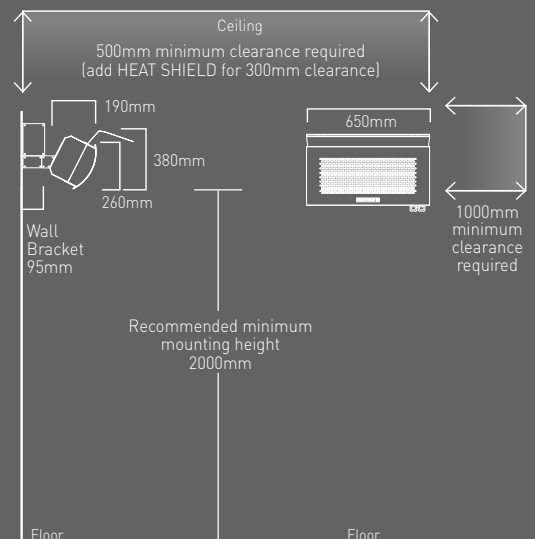

HEATSTRIP®

OUTDOOR HEATERS

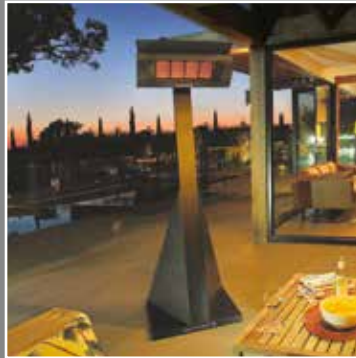

HEATSTRIP® by Thermofilm Australia Pty Ltd

HEATSTRIP is a range of world class electric and gas heaters designed for both indoor and outdoor applications. The multi-award winning range includes achievements such as Good Design Award, Australian Business Award for Product Value and Victorian Manufacturer of the Year. HEATSTRIP range is proudly designed and engineered in Australia, and exported to the world.



Thermofilm Australia Pty Ltd

17 Johnston Court, Dandenong South, Victoria 3175, Australia.

p: (03) 9562 3455 | f: (03) 9548 3979 | e: sales@thermofilm.com.au

www.facebook.com/ThermofilmAustralia

heatstrip.com.au

